

**NEW**  
Preliminary

# Whirlpool® 30" Single Wall Oven WOS51EC0A

## KEY FEATURES

- 30" Single Wall Oven
- AccuBake® Temperature Management System
- 5.0 cu. ft. Oven Capacity
- Traditional Self-Clean System
- SteamClean Option
- FIT System
- New Whirlpool® Design
- Hidden Bake

## COLORS

White(W)



Black(B)



Biscuit(T)



Stainless  
Steel(S)





# Whirlpool® 30" Single Wall Oven WOS51ECO A

## SPECIFICATIONS

MODEL #	WOS51ECO A
TRANSITIONED FROM MODEL #	RBS305PV
<b>FEATURES</b>	
Capacity (cu. ft.)	5.0
Self-Cleaning	Yes with Steam Clean
Rack Configuration	2 Racks with Integrated Handles
<b>GENERAL OVEN FEATURES</b>	
Bake Element (Watts) @240/208 V	2800/2427
Broil Element (Watts) @240/208 V	3600/3120
Broil Passes	8
Oven Cavity Size (in.)	18 in. H x 25 in. W x 19 in. D
AccuBake® Temperature Management System	Yes
Hidden Bake	Yes
Delay Bake	Yes
Sabbath Mode	Yes
Closed Door Broiling	Yes
Rack Positions	6
Control Type	Membrane
Control Lockout	Yes
Oven Controls Display Type	VFD
Oven Controls Display Color	Blue / Red
Oven Light(s)	2 Incandescent
Approved for Under-Cooktop Installation	Yes
<b>SPECIFICATIONS</b>	
Power Supply Connection Location	3" Below Support Platform on Left or Right Hand side
Sales Demo Mode	Yes
Total Connected Load (kW) @ 240 volts	3.684
Total Connected Load (kW) @ 208 volts	2.788
Circuit (amps)	30
Approx. Shipping Weight (lbs.)	165
Handle Type	Metal
FIT System feet and trims supplied with oven	Yes
<b>COLORS</b>	<b>W, B, S, T</b>

W=White, B=Black, S=Stainless Steel, T=Biscuit

## DIMENSIONS

### PRODUCT DIMENSIONS

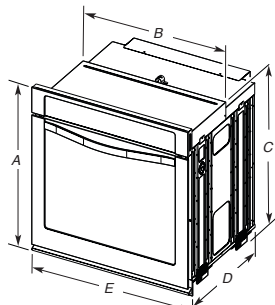

**30" (76.2 cm) models**  
 A. 28<sup>3</sup>/<sub>4</sub>" (72.8 cm) max. overall height  
 B. 28<sup>1</sup>/<sub>2</sub>" (72.4 cm) max. recessed width  
 C. 26<sup>1</sup>/<sub>2</sub>" (67.9 cm) recessed height  
 D. 23<sup>1</sup>/<sub>2</sub>" (59.1 cm) max. recessed depth  
 E. 30" (76.2 cm) overall width

### CABINET DIMENSIONS

#### Single Ovens Installed in Cabinet

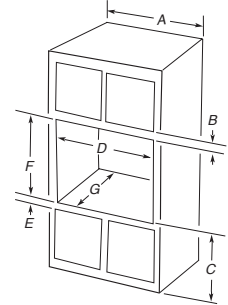

**30" (76.2 cm) models**  
 A. 30" (76.2 cm) min. cabinet width  
 B. 1" (2.5 cm) top of cutout to bottom of upper cabinet door  
 C. 32" (81.3 cm) bottom of cutout to floor  
 D. 28<sup>1</sup>/<sub>2</sub>" (72.4 cm) cutout width  
 E. 1<sup>1</sup>/<sub>2</sub>" (3.8 cm) min. bottom of cutout to top of cabinet door  
 F. 28" (71.2 cm)\* recommended cutout height  
 G. 24" (60.7 cm) cutout depth

**NOTE:** The cutout height can be between 26<sup>9</sup>/<sub>32</sub>" (68.4 cm) and 29<sup>9</sup>/<sub>32</sub>" (74.8 cm) for single ovens.

### CABINET DIMENSIONS

#### Single Oven Undercounter (without cooktop installed above)

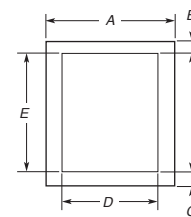

**30" (76.2 cm) models**  
 A. 30" (76.2 cm) min. cabinet width  
 B. 1<sup>1</sup>/<sub>2</sub>" (3.8 cm) min. top of cutout to underside of countertop  
 C. 5<sup>1</sup>/<sub>4</sub>" (13.3 cm) bottom of cutout to floor  
 D. 28<sup>1</sup>/<sub>2</sub>" (72.4 cm) cutout width  
 E. 28" (71.2 cm) min. cutout height

<b>CUTOUT DIMENSIONS</b>	
Height	26 29/32 to 29 13/32
Width	28 1/2
Depth	24
Bottom of cutout to floor (undercounter)	5 1/4
Bottom of cutout to floor (in-wall)	32
<b>PRODUCT DIMENSIONS</b>	
Overall Height	28 3/4
Overall Width	30
Overall Depth	26 3/8
Depth with door open 90 degrees	46 3/4

All dimensions are shown in inches.

**Dimensions are for planning purposes only.**  
**For complete details, see Installation Instructions packed with product.**  
**Specifications subject to change without notice.**

**NEW**  
Preliminary

# Whirlpool® 30" Single Wall Oven WOS92ECO

## KEY FEATURES

- 30" Single Wall Oven
- True Convection System with Convection Conversion
- 5.0 cu. ft. Oven Capacity
- AccuBake® Temperature Management System
- Rapid Preheat
- Traditional Self-Clean System
- SteamClean Option
- FIT System
- New Whirlpool® Design
- Hidden Bake



## COLORS

White(W)



Black(B)



Stainless  
Steel(S)



Black w/Silver  
Handle(E)



White w/Silver  
Handle(H)





# Whirlpool® 30" Single Wall Oven WOS92ECO A

## SPECIFICATIONS

MODEL #	WOS92ECO A
TRANSITIONED FROM MODEL #	GBS309PV
<b>FEATURES</b>	
Capacity (cu. ft.)	5.0
True Convection System	Yes
Self-Cleaning	Yes with Steam Clean
Rack Configuration	3 Racks with Integrated Handles
<b>GENERAL OVEN FEATURES</b>	
Bake Element (Watts) @240/208 V	2800/2427
Broil Element (Watts) @240/208 V	3600/3120
Broil Passes	8
Oven Cavity Size (in.)	18 in. H x 25 in. W x 19 in. D
AccuBake® Temperature Management System	Yes
Hidden Bake	Yes
Delay Bake	Yes
Sabbath Mode	Yes
Closed Door Broiling	Yes
Rapid Pre-heat	Yes
Rack Positions	6
Control Type	Membrane
Control Lockout	Yes
Oven Controls Display Type	VFD
Oven Controls Display Color	Blue / Red
Oven Light(s)	2 Incandescent
Approved for Under-Cooktop Installation	Yes
<b>SPECIFICATIONS</b>	
Power Supply Connection Location	3" Below Support Platform on Left or Right Hand side
Sales Demo Mode	Yes
Total Connected Load (kW) @ 240 volts	3.715
Total Connected Load (kW) @ 208 volts	2.819
Circuit (amps)	30
Approx. Shipping Weight (lbs.)	165
Handle Type	Metal
FIT System feet and trims supplied with oven	Yes
<b>COLORS</b>	<b>W, B, S, E, H</b>

W=White, B=Black, S=Stainless Steel,  
E=Black w/Silver Handle, H=White w/Silver Handle

## DIMENSIONS

### PRODUCT DIMENSIONS

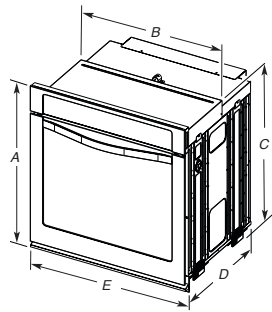

**30" (76.2 cm) models**  
 A. 28<sup>3</sup>/<sub>8</sub>" (72.8 cm) max. overall height  
 B. 28<sup>1</sup>/<sub>2</sub>" (72.4 cm) max. recessed width  
 C. 26<sup>1</sup>/<sub>2</sub>" (67.9 cm) recessed height  
 D. 23<sup>1</sup>/<sub>2</sub>" (59.1 cm) max. recessed depth  
 E. 30" (76.2 cm) overall width

### CABINET DIMENSIONS

Single Ovens Installed in Cabinet

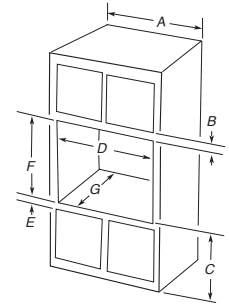

**30" (76.2 cm) models**  
 A. 30" (76.2 cm) min. cabinet width  
 B. 1" (2.5 cm) top of cutout to bottom of upper cabinet door  
 C. 32" (81.3 cm) bottom of cutout to floor  
 D. 28<sup>1</sup>/<sub>2</sub>" (72.4 cm) cutout width  
 E. 1<sup>1</sup>/<sub>2</sub>" (3.8 cm) min. bottom of cutout to top of cabinet door  
 F. 28" (71.2 cm)\* recommended cutout height  
 G. 24" (60.7 cm) cutout depth

**NOTE:** The cutout height can be between 26<sup>29</sup>/<sub>32</sub>" (68.4 cm) and 29<sup>13</sup>/<sub>32</sub>" (74.8 cm) for single ovens.

### CABINET DIMENSIONS

Single Oven Undercounter (without cooktop installed above)

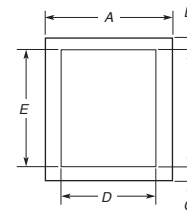

**30" (76.2 cm) models**  
 A. 30" (76.2 cm) min. cabinet width  
 B. 1<sup>1</sup>/<sub>2</sub>" (3.8 cm) min. top of cutout to underside of countertop  
 C. 5<sup>1</sup>/<sub>2</sub>" (13.3 cm) bottom of cutout to floor  
 D. 28<sup>1</sup>/<sub>2</sub>" (72.4 cm) cutout width  
 E. 28" (71.2 cm) min. cutout height

<b>CUTOUT DIMENSIONS</b>	
Height	26 29/32 to 29 13/32
Width	28 1/2
Depth	24
Bottom of cutout to floor (undercounter)	5 1/4
Bottom of cutout to floor (in-wall)	32
<b>PRODUCT DIMENSIONS</b>	
Overall Height	28 3/4
Overall Width	30
Overall Depth	26 3/8
Depth with door open 90 degrees	46 3/4

All dimensions are shown in inches.

**Dimensions are for planning purposes only.**  
**For complete details, see Installation Instructions packed with product.**  
**Specifications subject to change without notice.**

**NEW**  
Preliminary

# Whirlpool® 27" Single Wall Oven WOS51EC7A

## KEY FEATURES

- 27" Single Wall Oven
- AccuBake® Temperature Management System
- 4.3 cu. ft. Oven Capacity
- Traditional Self-Clean System
- SteamClean Option
- FIT System
- New Whirlpool® Design
- Hidden Bake



## COLORS

Stainless  
Steel(S)

Black w/Silver  
Handle(E)

White w/Silver  
Handle(H)





# Whirlpool® 27" Single Wall Oven WOS51EC7A

## SPECIFICATIONS

MODEL #	WOS51EC7A
TRANSITIONED FROM MODEL #	RBS275PV
<b>FEATURES</b>	
Capacity (cu. ft.)	4.3
Self-Cleaning	Yes
Rack Configuration	2 Racks with Integrated Handles
<b>GENERAL OVEN FEATURES</b>	
Bake Element (Watts) @ 240/208 V	2800/2427
Broil Element (Watts) @ 240/208 V	3600/3120
Broil Passes	8
Oven Cavity Size (in.)	18 in. H x 22 in. W x 19 in. D
AccuBake® Temperature Management System	Yes
Hidden Bake	Yes
Delay Bake	Yes
Sabbath Mode	Yes
Closed Door Broiling	Yes
Rack Positions	6
Control Type	Membrane
Control Lockout	Yes
Oven Controls Display Type	VFD
Oven Controls Display Color	Blue / Red
Oven Light(s)	2 Incandescent
Approved for Under-Cooktop Installation	Yes
<b>SPECIFICATIONS</b>	
Power Supply Connection Location	3" Below Support Platform on Left or Right Hand side
Sales Demo Mode	Yes
Total Connected Load (kW) @ 240 volts	3.684
Total Connected Load (kW) @ 208 volts	2.788
Circuit (amps)	30
Approx. Shipping Weight (lbs.)	138
Handle Type	Metal
FIT System feet and trims supplied with oven	Yes
<b>COLORS</b>	W, B, S, T

W=White, B=Black, S=Stainless Steel, T=Biscuit

## DIMENSIONS

### PRODUCT DIMENSIONS

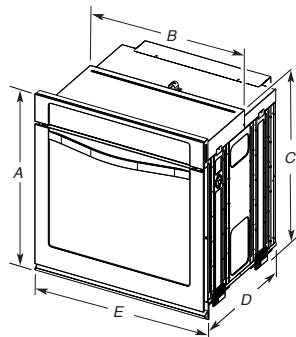

**27" (68.6 cm) models**  
 A. 28<sup>3</sup>/<sub>4</sub>" (72.8 cm) max. overall height  
 B. 25<sup>7</sup>/<sub>16</sub>" (64.6 cm) max. recessed width  
 C. 26<sup>7</sup>/<sub>8</sub>" (67.9 cm) recessed height  
 D. 23<sup>1</sup>/<sub>4</sub>" (59.1 cm) max. recessed depth  
 E. 27" (68.6 cm) overall width

### CABINET DIMENSIONS

Single Ovens Installed in Cabinet

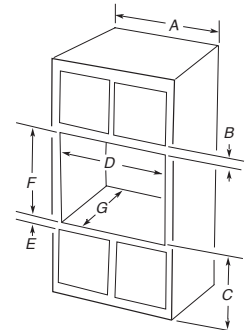

**27" (68.6 cm) models**  
 A. 27" (68.6 cm) min. cabinet width  
 B. 1" (2.5 cm) top of cutout to bottom of upper cabinet door  
 C. 32" (81.3 cm) bottom of cutout to floor  
 D. 25<sup>1</sup>/<sub>2</sub>" (64.8 cm) cutout width  
 E. 1<sup>1</sup>/<sub>2</sub>" (3.8 cm) min. bottom of cutout to top of cabinet door  
 F. 28" (71.2 cm)\* recommended cutout height  
 G. 24" (60.7 cm) cutout depth

**NOTE:** The cutout height can be between 26<sup>7</sup>/<sub>16</sub>" (68.4 cm) and 29<sup>13</sup>/<sub>16</sub>" (74.8 cm) for single ovens.

### CABINET DIMENSIONS

Single Oven Undercounter (without cooktop installed above)

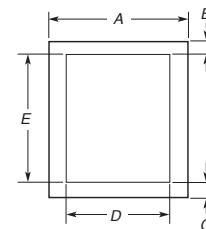

**27" (68.6 cm) models**  
 A. 27" (68.6 cm) min. cabinet width  
 B. 1<sup>1</sup>/<sub>2</sub>" (3.8 cm) min. top of cutout to underside of countertop

<b>CUTOUT DIMENSIONS</b>	
Height	26 29/32 to 29 13/32
Width	25 1/2
Depth	24
Bottom of cutout to floor (undercounter)	5 1/4
Bottom of cutout to floor (in-wall)	32
<b>PRODUCT DIMENSIONS</b>	
Overall Height	28 3/4
Overall Width	27
Overall Depth	26 3/8
Depth with door open 90 degrees	46 3/4

All dimensions are shown in inches.

Dimensions are for planning purposes only.  
 For complete details, see Installation Instructions packed with product.  
 Specifications subject to change without notice.

**NEW**  
Preliminary

# Whirlpool® 27" Single Wall Oven WOS92EC7A

## KEY FEATURES

- 27" Single Wall Oven
- True Convection System with Convection Conversion
- 4.3 cu. ft. Oven Capacity
- AccuBake® Temperature Management System
- Rapid Preheat
- Traditional Self-Clean System
- SteamClean Option
- FIT System
- New Whirlpool® Design
- Hidden Bake



## COLORS

White(W)



Black(B)



Stainless  
Steel(S)





# Whirlpool® 27" Single Wall Oven WOS92EC7A

## SPECIFICATIONS

MODEL #	WOS92EC7A
TRANSITIONED FROM MODEL #	GBS279PV
FEATURES	
Capacity (cu. ft.)	4.3
True Convection System	Yes
Self-Cleaning	Yes with Steam Clean
Rack Configuration	3 Racks with Integrated Handles
GENERAL OVEN FEATURES	
Bake Element (Watts) @240/208 V	2800/2427
Broil Element (Watts) @240/208 V	3600/3120
Broil Passes	8
Oven Cavity Size (in.)	18 in. H x 22 in. W x 19 in. D
AccuBake® Temperature Management System	Yes
Hidden Bake	Yes
Delay Bake	Yes
Sabbath Mode	Yes
Closed Door Broiling	Yes
Rapid Pre-heat	Yes
Rack Positions	6
Control Type	Membrane
Control Lockout	Yes
Oven Controls Display Type	VFD
Oven Controls Display Color	Blue / Red
Oven Light(s)	2 Incandescent
Approved for Under-Cooktop Installation	Yes
SPECIFICATIONS	
Power Supply Connection Location	3" Below Support Platform on Left or Right Hand side
Sales Demo Mode	Yes
Total Connected Load (kW) @ 240 volts	3.715
Total Connected Load (kW) @ 208 volts	2.819
Circuit (amps)	30
Approx. Shipping Weight (lbs.)	138
Handle Type	Metal
FIT System feet and trims supplied with oven	Yes
COLORS	
	W, B, S

W=White, B=Black, S=Stainless Steel

## DIMENSIONS

### PRODUCT DIMENSIONS

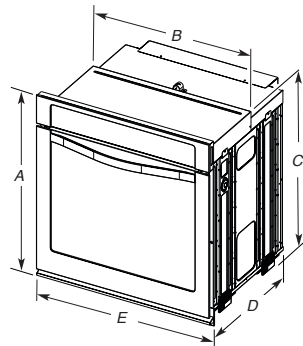

**27" (68.6 cm) models**  
 A. 28<sup>3/4"</sup> (72.8 cm) max. overall height  
 B. 25<sup>7/16"</sup> (64.6 cm) max. recessed width  
 C. 26<sup>3/8"</sup> (67.9 cm) recessed height  
 D. 23<sup>1/4"</sup> (59.1 cm) max. recessed depth  
 E. 27" (68.6 cm) overall width

### CABINET DIMENSIONS

Single Ovens Installed in Cabinet

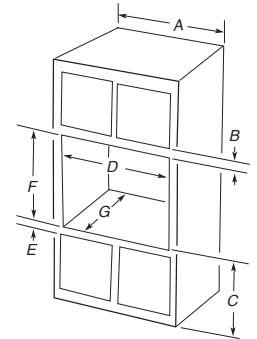

**27" (68.6 cm) models**  
 A. 27" (68.6 cm) min. cabinet width  
 B. 1" (2.5 cm) top of cutout to bottom of upper cabinet door  
 C. 32" (81.3 cm) bottom of cutout to floor  
 D. 25<sup>1/2"</sup> (64.8 cm) cutout width  
 E. 1<sup>1/2"</sup> (3.8 cm) min. bottom of cutout to top of cabinet door  
 F. 28" (71.2 cm)\* recommended cutout height  
 G. 24" (60.7 cm) cutout depth

**NOTE:** The cutout height can be between 26<sup>7/8"</sup> (68.4 cm) and 29<sup>13/32"</sup> (74.8 cm) for single ovens.

### CABINET DIMENSIONS

Single Oven Undercounter (without cooktop installed above)

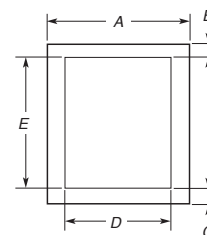

**27" (68.6 cm) models**  
 A. 27" (68.6 cm) min. cabinet width  
 B. 1<sup>1/2"</sup> (3.8 cm) min. top of cutout to underside of

CUTOUT DIMENSIONS	
Height	26 29/32 to 29 13/32
Width	25 1/2
Depth	24
Bottom of cutout to floor (undercounter)	5 1/4
Bottom of cutout to floor (in-wall)	32
PRODUCT DIMENSIONS	
Overall Height	28 3/4
Overall Width	27
Overall Depth	26 3/8
Depth with door open 90 degrees	46 3/4

All dimensions are shown in inches.

Dimensions are for planning purposes only.  
 For complete details, see Installation Instructions packed with product.  
 Specifications subject to change without notice.



**NEW**  
Preliminary

# Whirlpool® 30" Double Wall Oven WOD51ECO A

## KEY FEATURES

- 30" Double Wall Oven
- AccuBake® Temperature Management System
- 5.0 cu. ft. Oven Capacity
- Traditional Self-Clean System
- SteamClean Option
- FIT System
- New Whirlpool® Design
- Hidden Bake

## COLORS

White(W)



Black(B)



Biscuit(T)



Stainless  
Steel(S)





# Whirlpool® 30" Double Wall Oven WOD51EC0A

## SPECIFICATIONS

MODEL #	WOD51EC0A
TRANSITIONED FROM MODEL #	RBD305PV
<b>FEATURES (UPPER)</b>	
Capacity (cu. ft.)	5.0
Self-Clean with Steam Clean	Yes
Rack Configuration	2 Racks with Integrated Handles
<b>FEATURES (LOWER)</b>	
Capacity (cu. ft.)	5.0
Self-Cleaning	Yes
Rack Configuration	2 Racks with Integrated Handles
<b>GENERAL OVEN FEATURES</b>	
Bake Element (Watts) @ 240/208 V	2800/2427
Broil Element (Watts) @ 240/208 V	3600/3120
Broil Passes	8
Oven Cavity Size (in.)	18 in. H x 25 in. W x 19 in. D
AccuBake® Temperature Management System	Yes
Hidden Bake	Yes
Delay Bake	Yes
Sabbath Mode	Yes
Closed Door Broiling	Yes
Rack Positions	6
Control Type	Membrane
Control Lockout	Yes
Oven Controls Display Type	VFD
Oven Controls Display Color	Blue / Red
Oven Light(s)	2 Incandescent
<b>SPECIFICATIONS</b>	
Power Supply Connection Location	3" Below Support Platform on Left or Right Hand side
Sales Demo Mode	Yes
Total Connected Load (kW) @ 240 volts	7.368
Total Connected Load (kW) @ 208 volts	5.576
Circuit (amps)	30
Approx. Shipping Weight (lbs.)	266
Handle Type	Metal
FIT System feet and trims supplied with oven	Yes
<b>COLORS</b>	<b>W, B, T, S</b>

W=White, B=Black, T=Biscuit, S=Stainless Steel

## DIMENSIONS

### PRODUCT DIMENSIONS

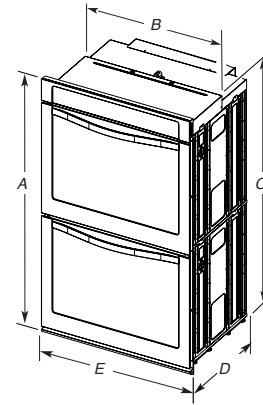

**30" (76.2 cm) models**  
 A. 51 7/8" (130.6 cm) max. overall height  
 B. 28 1/2" (72.4 cm) max. recessed width  
 C. 26 3/8" (124.0 cm) recessed height  
 D. 23 1/2" (59.1 cm) max. recessed depth  
 E. 30" (76.2 cm) overall width

### CABINET DIMENSIONS

#### Double Ovens Installed in Cabinet

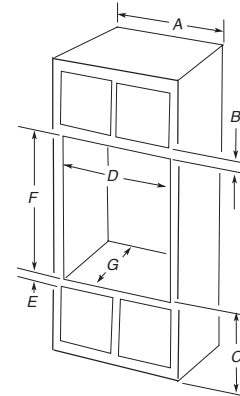

**30" (76.2 cm) models**  
 A. 30" (76.2 cm) min. cabinet width  
 B. 1" (2.5 cm) top of cutout to bottom of upper cabinet door  
 C. 14 1/4" (37.5 cm) bottom of cutout to floor  
 D. 28 1/2" (72.4 cm) cutout width  
 E. 1 1/2" (3.8 cm) min. bottom of cutout to top of cabinet door  
 F. 50 3/4" (127.2 cm)\* recommended cutout height  
 G. 24" (60.7 cm) cutout depth

**NOTE:** The cutout height can be between 48 7/8" (124.1 cm) and 52 13/64" (132.6 cm) for double ovens.

CUTOUT DIMENSIONS	
Height	48 7/8 to 52 13/64
Width	28 1/2
Depth	24
Bottom of cutout to floor (in-wall)	14 3/4
PRODUCT DIMENSIONS	
Height	51 7/16
Width	30
Depth	26 3/8
Depth with door open 90 degrees	46 3/4

All dimensions are shown in inches.

**Dimensions are for planning purposes only.**  
**For complete details, see Installation Instructions packed with product.**  
**Specifications subject to change without notice.**

**NEW**  
Preliminary

# Whirlpool® 30" Double Wall Oven WOD93ECO0A

## KEY FEATURES

- 30" Double Wall Oven
- True Convection System with Convection Conversion
- 5.0 cu. ft. oven capacity
- AccuBake® Temperature Management System
- Rapid Preheat
- Traditional Self-Clean System
- SteamClean Option
- FIT System
- New Whirlpool® Design
- Hidden Bake

## COLORS

White(W)



Black(B)



Stainless Steel(S)



Black w/Silver Handle(E)



White w/Silver Handle(H)





# Whirlpool® 30" Double Wall Oven WOD93ECA

## SPECIFICATIONS

MODEL #	WOD93ECA
TRANSITIONED FROM MODEL #	GBD309PV
<b>FEATURES (UPPER)</b>	
Capacity (cu. ft.)	5.0
True Convection System	Yes
Self-Cleaning	Yes with Steam Clean
Rack Configuration	3 Racks with Integrated Handles
<b>FEATURES (LOWER)</b>	
Capacity (cu. ft.)	5.0
Self-Cleaning	Yes with Steam Clean
Rack Configuration	2 Racks with Integrated Handles
<b>GENERAL OVEN FEATURES</b>	
Bake Element (Watts) @ 240/208 V	2800/2427
Broil Element (Watts) @240/208 V	3600/3120
Broil Passes	8
Oven Cavity Size (in.)	18 in. H x 25 in. W x 19 in. D
AccuBake® Temperature Management System	Yes
Hidden Bake	Yes
Delay Bake	Yes
Sabbath Mode	Yes
Closed Door Broiling	Yes
Rapid Pre-heat	Yes
Rack Positions	6
Control Type	Membrane
Control Lockout	Yes
Oven Controls Display Type	VFD
Oven Controls Display Color	Blue / Red
Oven Light(s)	2 Incandescent
<b>SPECIFICATIONS</b>	
Power Supply Connection Location	3" Below Support Platform on Left or Right Hand side
Sales Demo Mode	Yes
Total Connected Load (kW) @ 240 volts	7.399
Total Connected Load (kW) @ 208 volts	5.607
Circuit (amps)	30
Approx. Shipping Weight (lbs.)	266
Handle Type	Metal
FIT System feet and trims supplied with oven	Yes
<b>COLORS</b>	<b>W, B, S, E, H</b>

W=White, B=Black, S=Stainless Steel,  
E=Black w/Silver Handle, H=White w/Silver Handle

## DIMENSIONS

### PRODUCT DIMENSIONS

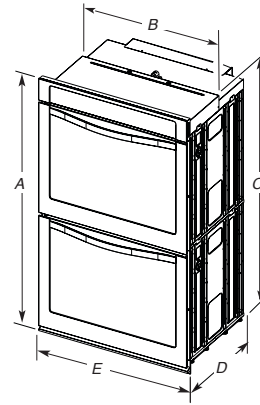

**30" (76.2 cm) models**  
 A. 51 7/16" (130.6 cm) max. overall height  
 B. 28 1/2" (72.4 cm) max. recessed width  
 C. 26 3/8" (124.0 cm) recessed height  
 D. 23 1/2" (59.1 cm) max. recessed depth  
 E. 30" (76.2 cm) overall width

### CABINET DIMENSIONS

#### Double Ovens Installed in Cabinet

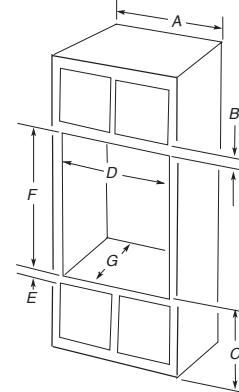

**30" (76.2 cm) models**  
 A. 30" (76.2 cm) min. cabinet width  
 B. 1" (2.5 cm) top of cutout to bottom of upper cabinet door  
 C. 14 1/4" (37.5 cm) bottom of cutout to floor  
 D. 28 1/2" (72.4 cm) cutout width  
 E. 1 1/2" (3.8 cm) min. bottom of cutout to top of cabinet door  
 F. 50 1/4" (127.2 cm)\* recommended cutout height  
 G. 24" (60.7 cm) cutout depth

**NOTE:** The cutout height can be between 48 7/32" (124.1 cm) and 52 19/64" (132.6 cm) for double ovens.

CUTOUT DIMENSIONS	
Height	48 7/8 to 52 13/64
Width	28 1/2
Depth	24
Bottom of cutout to floor (in-wall)	14 3/4
PRODUCT DIMENSIONS	
Height	51 7/16
Width	30
Depth	26 3/8
Depth with door open 90 degrees	46 3/4

All dimensions are shown in inches.

**Dimensions are for planning purposes only.**  
**For complete details, see Installation Instructions packed with product.**  
**Specifications subject to change without notice.**

**NEW**  
Preliminary

# Whirlpool® 27" Double Wall Oven WOD51EC7A

## KEY FEATURES

- 27" Double Wall Oven
- AccuBake® Temperature Management System
- 4.3 cu. ft. Oven Capacity
- Traditional Self-Clean System
- SteamClean Option
- FIT System
- New Whirlpool® Design
- Hidden Bake

## COLORS

White(W)



Black(B)



Biscuit(T)



Stainless  
Steel(S)





# Whirlpool® 27" Double Wall Oven WOD51EC7A

## SPECIFICATIONS

MODEL #	WOD51EC7A
TRANSITIONED FROM MODEL #	RBD275PV
<b>FEATURES (UPPER)</b>	
Capacity (cu. ft.)	4.3
Self-Cleaning	Yes with Steam Clean
Rack Configuration	2 Racks with Integrated Handles
<b>FEATURES (LOWER)</b>	
Capacity (cu. ft.)	4.3
Self-Cleaning	Yes
Rack Configuration	2 Racks with Integrated Handles
<b>GENERAL OVEN FEATURES</b>	
Bake Element (Watts) @ 240/208 V	2800/2427
Broil Element (Watts) @ 240/208 V	3600/3120
Broil Passes	8
Oven Cavity Size (in.)	18 in. H x 22 in. W x 19 in. D
AccuBake® Temperature Management System	Yes
Hidden Bake	Yes
Delay Bake	Yes
Sabbath Mode	Yes
Closed Door Broiling	Yes
Rack Positions	6
Control Type	Membrane
Control Lockout	Yes
Oven Controls Display Type	VFD
Oven Controls Display Color	Blue / Red
Oven Light(s)	2 Incandescent
<b>SPECIFICATIONS</b>	
Power Supply Connection Location	3" Below Support Platform on Left or Right Hand side
Sales Demo Mode	Yes
Total Connected Load (kW) @ 240 volts	7.368
Total Connected Load (kW) @ 208 volts	5.576
Circuit (amps)	30
Approx. Shipping Weight (lbs.)	244 1/2
Handle Type	Metal
FIT System feet and trims supplied with oven	Yes
<b>COLORS</b>	<b>W, B, T, S</b>

W=White, B=Black, T=Biscuit, S=Stainless Steel

## DIMENSIONS

### PRODUCT DIMENSIONS

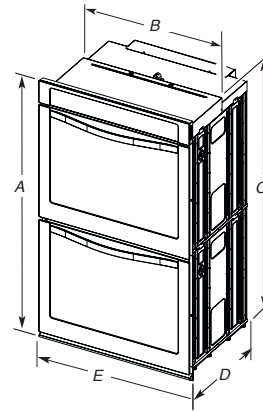

**27" (68.6 cm) models**  
 A. 51 7/8" (130.6 cm) max. overall height  
 B. 25 7/8" (64.6 cm) max. recessed width  
 C. 48 1/2" (124.0 cm) recessed height  
 D. 23 1/4" (59.1 cm) max. recessed depth  
 E. 27" (68.6 cm) overall width

### CABINET DIMENSIONS

#### Double Ovens Installed in Cabinet

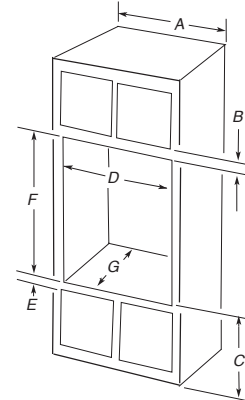

**27" (68.6 cm) models**  
 A. 27" (68.6 cm) min. cabinet width  
 B. 1" (2.5 cm) top of cutout to bottom of upper cabinet door  
 C. 14 3/4" (37.5 cm) bottom of cutout to floor  
 D. 25 1/2" (64.8 cm) cutout width  
 E. 1 1/2" (3.8 cm) min. bottom of cutout to top of cabinet door  
 F. 50 3/4" (127.2 cm)\* recommended cutout height  
 G. 24" (60.7 cm) cutout depth

**NOTE:** The cutout height can be between 48<sup>29</sup>/<sub>32</sub>" (124.1 cm) and 52<sup>5</sup>/<sub>64</sub>" (132.6 cm) for double ovens.

CUTOUT DIMENSIONS		
Height	48 7/8 to 52 13/64	
Width	25 1/2	
Depth	24	
Bottom of cutout to floor (in-wall)	14 3/4	
PRODUCT DIMENSIONS		
Height	51 7/16	
Width	27	
Depth	26 3/8	
Depth with door open 90 degrees	46 3/4	

All dimensions are shown in inches.

Dimensions are for planning purposes only.  
 For complete details, see Installation Instructions packed with product.  
 Specifications subject to change without notice.

**NEW**  
Preliminary

# Whirlpool® 27" Double Wall Oven WOD93EC7A

## KEY FEATURES

- 27" Double Wall Oven
- True Convection System with Convection Conversion
- 4.3 cu. ft. Oven Capacity
- AccuBake® Temperature Management System
- Rapid Preheat
- Traditional Self-Clean System
- SteamClean Option
- FIT System
- New Whirlpool® Design
- Hidden Bake

## COLORS

White(W)



Black(B)



Stainless  
Steel(S)





# Whirlpool® 27" Double Wall Oven WOD93EC7A

## SPECIFICATIONS

MODEL #	WOD93EC7A
TRANSITIONED FROM MODEL #	GBD279PV
<b>FEATURES (UPPER)</b>	
Capacity (cu. ft.)	4.3
True Convection System	Yes
Self-Cleaning	Yes with Steam Clean
Rack Configuration	3 Racks with Integrated Handles
<b>FEATURES (LOWER)</b>	
Capacity (cu. ft.)	4.3
Self-Cleaning	Yes
Rack Configuration	2 Racks with Integrated Handles
<b>GENERAL OVEN FEATURES</b>	
Bake Element (Watts) @ 240/208 V	2800/2427
Broil Element (Watts) @ 240/208 V	3600/3120
Broil Passes	8
Oven Cavity Size (in.)	18 in. H x 22 in. W x 19 in. D
AccuBake® Temperature Management System	Yes
Hidden Bake	Yes
Delay Bake	Yes
Sabbath Mode	Yes
Closed Door Broiling	Yes
Rapid Pre-heat	Yes
Rack Positions	6
Control Type	Membrane
Control Lockout	Yes
Oven Controls Display Type	VFD
Oven Controls Display Color	Blue / Red
Oven Light(s)	2 Incandescent
<b>SPECIFICATIONS</b>	
Power Supply Connection Location	3" Below Support Platform on Left or Right Hand side
Sales Demo Mode	Yes
Total Connected Load (kW) @ 240 volts	7.399
Total Connected Load (kW) @ 208 volts	5.607
Circuit (amps)	30
Approx. Shipping Weight (lbs.)	244 1/2
Handle Type	Metal
FIT System feet and trims supplied with oven	Yes
<b>COLORS</b>	<b>W, B, S</b>

W=White, B=Black, S=Stainless Steel

## DIMENSIONS

### PRODUCT DIMENSIONS

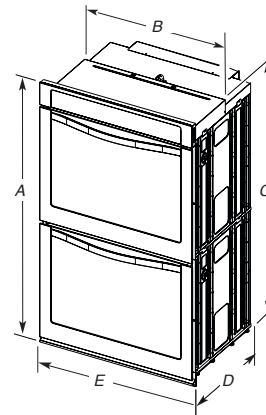

**27" (68.6 cm) models**  
 A. 51 7/16" (130.6 cm) max. overall height  
 B. 25 3/8" (64.6 cm) max. recessed width  
 C. 48 3/8" (124.0 cm) recessed height  
 D. 23 1/2" (59.1 cm) max. recessed depth  
 E. 27" (68.6 cm) overall width

### CABINET DIMENSIONS

#### Double Ovens Installed in Cabinet

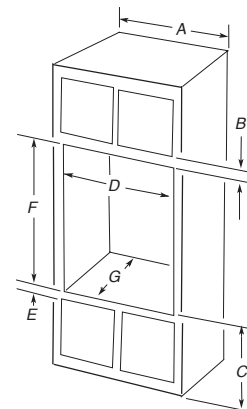

**27" (68.6 cm) models**  
 A. 27" (68.6 cm) min. cabinet width  
 B. 1" (2.5 cm) top of cutout to bottom of upper cabinet door  
 C. 14 3/4" (37.5 cm) bottom of cutout to floor  
 D. 25 1/2" (64.8 cm) cutout width  
 E. 1 1/2" (3.8 cm) min. bottom of cutout to top of cabinet door  
 F. 50 3/4" (127.2 cm)\* recommended cutout height  
 G. 24" (60.7 cm) cutout depth

**NOTE:** The cutout height can be between 48 29/32" (124.1 cm) and 52 13/64" (132.6 cm) for double ovens.

CUTOUT DIMENSIONS	
Height	48 7/8 to 52 13/64
Width	25 1/2
Depth	24
Bottom of cutout to floor (in-wall)	14 3/4
PRODUCT DIMENSIONS	
Height	51 7/16
Width	27
Depth	26 3/8
Depth with door open 90 degrees	46 3/4

All dimensions are shown in inches.

**Dimensions are for planning purposes only.**  
**For complete details, see Installation Instructions packed with product.**  
**Specifications subject to change without notice.**



**NEW**  
Preliminary

# Whirlpool® 30" Combo Wall Oven WOC54ECO

## KEY FEATURES

- 30" Combination Microwave-Wall Oven
- New Whirlpool® Design

## OVEN FEATURES

- AccuBake® Temperature Management System
- 5.0 cu. ft. Oven Capacity
- Traditional Self-Clean System
- SteamClean Option
- Hidden Bake

## MICROWAVE FEATURES

- Sensor Cooking
- 1.4 cu. ft. Capacity
- Stainless Steel Cavity
- 900 Watts

## COLORS

White(W)



Black(B)



Stainless  
Steel(S)

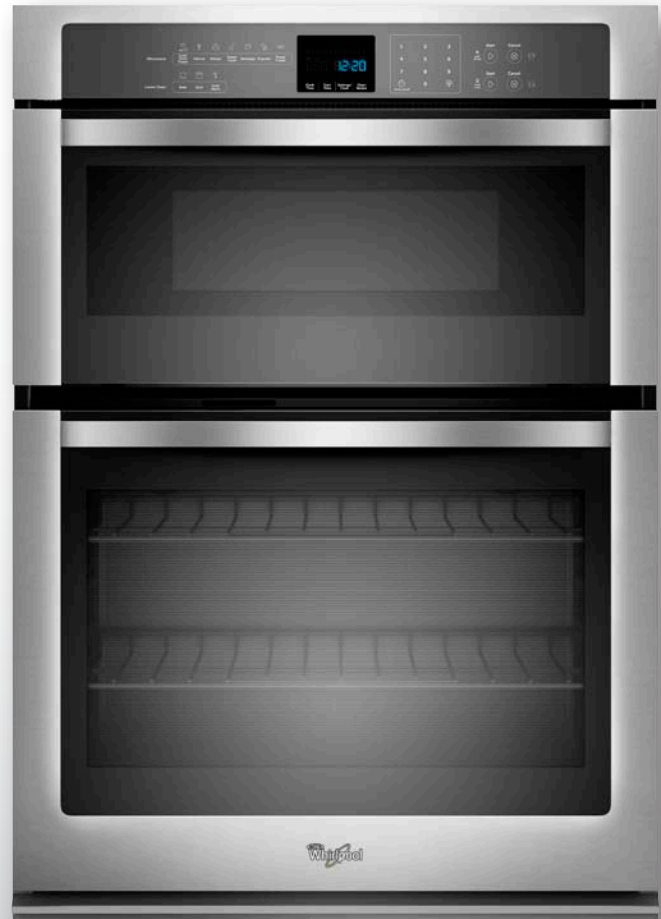



# Whirlpool® 30" Combo Wall Oven WOC54ECO A

## SPECIFICATIONS

MODEL #	WOC54ECO A
TRANSITIONED FROM MODEL #	RMC305PV
<b>FEATURES (UPPER)</b>	
Microwave Oven Capacity (cu. Ft.)	1.4
Microwave Oven Cavity Size (in.)	8.25 in. H x 16.5 in. W x 17.75 in. D
Diameter of Turntable (in.)	14 1/8
Microwave Wattage	900
Sensor Cooking	Yes
Inverter TE	Yes
<b>FEATURES (LOWER)</b>	
Capacity (cu. ft.)	5.0
Self-Cleaning	Yes
Rack Configuration	2 Racks with Integrated Handles
<b>GENERAL OVEN FEATURES</b>	
Bake Element (Watts) @ 240/208 V	2800/2427
Broil Element (Watts) @ 240/208 V	3600/3120
Broil Passes	8
Oven Cavity Size (in.)	18 in. H x 25 in. W x 19 in. D
AccuBake® Temperature Management System	Yes
Hidden Bake	Yes
Delay Bake	Yes
Sabbath Mode	Yes
Closed Door Broiling	Yes
Rack Positions	6
Control Type	Membrane
Control Lockout	Yes
Oven Controls Display Type	VFD
Oven Controls Display Color	Blue / Red
Oven Light(s)	2 Incandescent
<b>SPECIFICATIONS</b>	
Power Supply Connection Location	3" Below Support Platform on Left or Right Hand side
Sales Demo Mode	Yes
Circuit (amps)	40
Approx. Shipping Weight (lbs.)	235
Handle Type	Metal
<b>COLORS</b>	<b>W, B, S</b>

W=White, B=Black, S=Stainless Steel

## DIMENSIONS

### PRODUCT DIMENSIONS

30" (76.2 cm) Ovens

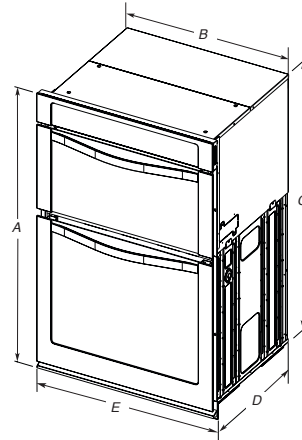

30" (76.2 cm) models  
 A. 42 5/8" (108.0 cm) overall height  
 B. 28 1/2" (72.3 cm) recessed width  
 C. 41" (104.1 cm) recessed depth  
 D. 23 1/2" (59.1 cm) max. recessed depth  
 E. 30" (76.2 cm) overall width

### CABINET DIMENSIONS

30" (76.2 cm) Ovens

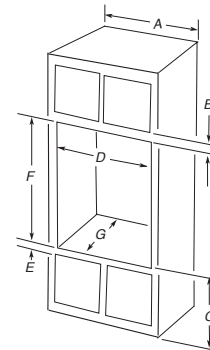

30" (76.2 cm) models  
 A. 30" (76.2 cm) min. cabinet width  
 B. 1" (2.5 cm) top of cutout to bottom of upper cabinet door  
 C. 19 1/2" (48.9 cm) bottom of cutout to floor  
 D. 28 1/2" (72.4 cm) cutout width  
 E. 1 1/2" (3.8 cm) min. bottom of cutout to top of cabinet door  
 F. 41 5/8" (105 cm)\* recommended cutout height  
 G. 24" (60.7 cm) cutout depth

\*NOTE: The cabinet height can be between 41" (104.1 cm) and 41 1/2" (105.6 cm) for double ovens.

CUTOUT DIMENSIONS		
Height	41 to 41 1/2	
Width	28 1/2	
Depth	24	
Bottom of cutout to floor (in-wall)	19 1/4	
PRODUCT DIMENSIONS		
Height	42 9/16	
Width	30	
Depth	26 3/8	
Depth with door open 90 degrees	46 3/4	

All dimensions are shown in inches.

Dimensions are for planning purposes only.  
 For complete details, see Installation Instructions packed with product.  
 Specifications subject to change without notice.

**NEW**  
Preliminary

# Whirlpool® 30" Combo Wall Oven WOC95ECA

## KEY FEATURES

- 30" Combination Microwave-Wall Oven
- New Whirlpool® Design

## OVEN FEATURES

- True Convection System with Convection Conversion
- 5.0 cu. ft. Oven Capacity
- AccuBake® Temperature Management System
- Traditional Self-Clean System
- SteamClean Option
- Hidden Bake

## MICROWAVE FEATURES

- Sensor Cooking
- 1.4 cu. ft. Capacity
- Stainless Steel Cavity
- 900 Watts

## COLORS

White(W)



Black(B)



Stainless Steel(S)



Black w/Silver Handle(E)



White w/Silver Handle(H)





# Whirlpool® 30" Combo Wall Oven WOC95ECO A

## SPECIFICATIONS

MODEL #	WOC95ECO A
TRANSITIONED FROM MODEL #	GSC309PV
FEATURES (UPPER)	
Microwave Oven Capacity (cu. Ft.)	1.4
Microwave Oven Cavity Size (in.)	8.25 in. H x 16.5 in. W x 17.75 in. D
Diameter of Turntable (in.)	14 1/8
Microwave Wattage	900
Convection	Yes
Sensor Cooking	Yes
Inverter TE	Yes
FEATURES (LOWER)	
Capacity (cu. ft.)	5.0
Self-Cleaning	Yes with Steam Clean
Rack Configuration	3 Racks with Integrated Handles
True Convection	Yes
GENERAL OVEN FEATURES	
Bake Element (Watts) @ 240/208 V	2800/2427
Broil Element (Watts) @ 240/208 V	3600/3120
Broil Passes	8
Oven Cavity Size (in.)	18 in. H x 25 in. W x 19 in. D
AccuBake® Temperature Management System	Yes
Hidden Bake	Yes
Delay Bake	Yes
Sabbath Mode	Yes
Closed Door Broiling	Yes
Rapid Pre-heat	Yes
Rack Positions	6
Control Type	Membrane
Oven Controls Display Type	VFD
Oven Controls Display Color	Blue / Red
Oven Light(s)	2 Incandescent
SPECIFICATIONS	
Power Supply Connection Location	3" Below Support Platform on Left or Right Hand side
Sales Demo Mode	Yes
Circuit (amps)	40
Approx. Shipping Weight (lbs.)	235
Handle Type	Metal
COLORS	
	W, B, S, E, H

W=White, B=Black, S=Stainless Steel,  
E=Black w/Silver Handle, H=White w/Silver Handle

## DIMENSIONS

### PRODUCT DIMENSIONS

30" (76.2 cm) Ovens

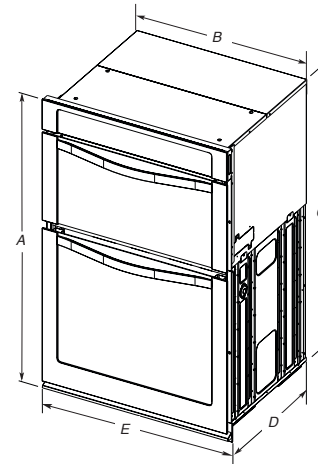

**30" (76.2 cm) models**  
 A. 42 3/8" (108.0 cm) overall height  
 B. 28 1/2" (72.3 cm) recessed width  
 C. 41" (104.1 cm) recessed height  
 D. 23 1/2" (59.1 cm) max. recessed depth  
 E. 30" (76.2 cm) overall width

### CABINET DIMENSIONS

30" (76.2 cm) Ovens

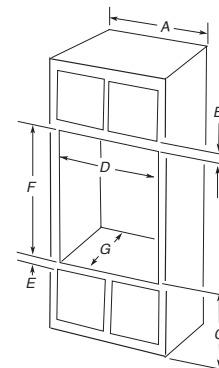

**30" (76.2 cm) models**  
 A. 30" (76.2 cm) min. cabinet width  
 B. 1" (2.5 cm) top of cutout to bottom of upper cabinet door  
 C. 19 1/2" (48.9 cm) bottom of cutout to floor  
 D. 28 1/2" (72.4 cm) cutout width  
 E. 1 1/2" (3.8 cm) min. bottom of cutout to top of cabinet door  
 F. 41 3/8" (105 cm)\* recommended cutout height  
 G. 24" (60.7 cm) cutout depth

\*NOTE: The cabinet height can be between 41" (104.1 cm) and 41 1/2" (105.6 cm) for double ovens.

CUTOUT DIMENSIONS		
Height		41 to 41 1/2
Width		28 1/2
Depth		24
Bottom of cutout to floor (in-wall)		19 1/4
PRODUCT DIMENSIONS		
Height		42 9/16
Width		30
Depth		26 3/8
Depth with door open 90 degrees		46 3/4

All dimensions are shown in inches.

Dimensions are for planning purposes only.  
 For complete details, see Installation Instructions packed with product.  
 Specifications subject to change without notice.

**NEW**  
Preliminary

# Whirlpool® 27" Combo Wall Oven WOC54EC7A

## KEY FEATURES

- 27" Combination Microwave-Wall Oven
- New Whirlpool® Design

## OVEN FEATURES

- AccuBake® Temperature Management System
- 4.3 cu. ft. Oven Capacity
- Traditional Self-Clean System
- SteamClean Option
- Hidden Bake

## MICROWAVE FEATURES

- Sensor Cooking
- 1.4 cu. ft. Capacity
- Stainless Steel Cavity
- 900 Watts

## COLORS

White(W)



Black(B)



Stainless Steel(S)

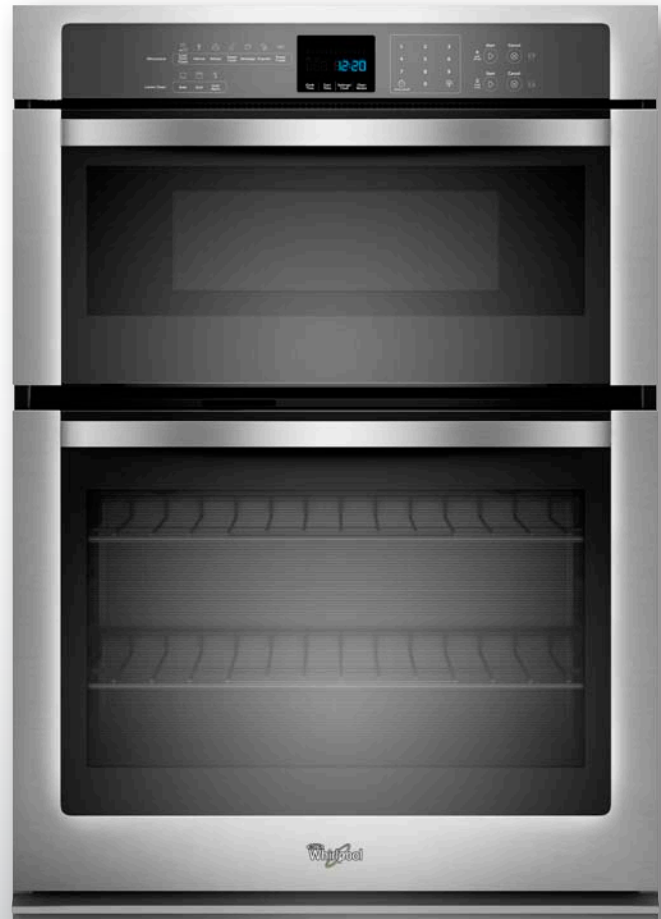



# Whirlpool® 27" Combo Wall Oven WOC54EC7A

## SPECIFICATIONS

<b>MODEL #</b>	<b>WOC54EC7A</b>
<b>TRANSITIONED FROM MODEL #</b>	<b>RMC275PV</b>
<b>FEATURES (UPPER)</b>	
Microwave Oven Capacity (cu. Ft.)	1.4
Microwave Oven Cavity Size (in.)	8.25 in. H x 16.5 in. W x 17.75 in. D
Diameter of Turntable (in.)	14 1/8
Microwave Wattage	900
Sensor Cooking	Yes
Inverter TE	Yes
<b>FEATURES (LOWER)</b>	
Capacity (cu. ft.)	4.3
Self-Cleaning	Yes
Rack Configuration	2 Racks with Integrated Handles
<b>GENERAL OVEN FEATURES</b>	
Bake Element (Watts) @ 240/208 V	2800/2427
Broil Element (Watts) @ 240/208 V	3600/3120
Broil Passes	8
Oven Cavity Size (in.)	18 in. H x 22 in. W x 19 in. D
AccuBake® Temperature Management System	Yes
Hidden Bake	Yes
Delay Bake	Yes
Sabbath Mode	Yes
Closed Door Broiling	Yes
Rack Positions	6
Control Type	Membrane
Oven Controls Display Type	VFD
Oven Controls Display Color	Blue / Red
Oven Light(s)	2 Incandescent
<b>SPECIFICATIONS</b>	
Power Supply Connection Location	3" Below Support Platform on Left or Right Hand side
Sales Demo Mode	Yes
Circuit (amps)	40
Handle Type	Metal
<b>COLORS</b>	<b>W, B, S</b>

W=White, B=Black, S=Stainless Steel

## DIMENSIONS

### PRODUCT DIMENSIONS

27" (68.6 cm)

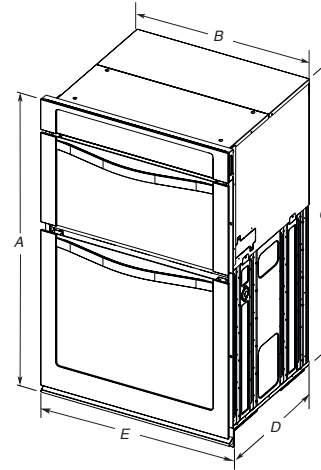

**27" (68.6 cm) models**  
 A. 42<sup>9</sup>/<sub>16</sub>" (108.0 cm) overall height  
 B. 25<sup>7</sup>/<sub>8</sub>" (64.6 cm) recessed width  
 C. 41" (104.1 cm) recessed height  
 D. 23<sup>1</sup>/<sub>2</sub>" (59.1 cm) max. recessed depth  
 E. 27" (68.6 cm) overall width

### CABINET DIMENSIONS

27" (68.6 cm)

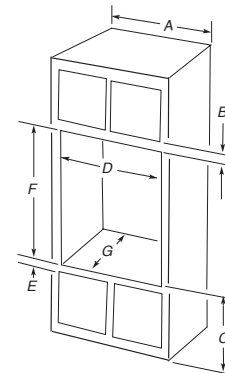

**27" (68.6 cm) models**  
 A. 27" (68.6 cm) min. cabinet width  
 B. 1" (2.5 cm) top of cutout to bottom of upper cabinet door  
 C. 19<sup>1</sup>/<sub>2</sub>" (48.9 cm) bottom of cutout to floor  
 D. 25<sup>1</sup>/<sub>2</sub>" (64.8 cm) cutout width  
 E. 1<sup>1</sup>/<sub>2</sub>" (3.8 cm) min. bottom of cutout to top of cabinet door  
 F. 41<sup>5</sup>/<sub>8</sub>" (105 cm)\* recommended cutout height  
 G. 24" (60.7 cm) cutout depth

\*NOTE: The cabinet height can be between 41" (104.1 cm) and 41<sup>1</sup>/<sub>2</sub>" (105.6 cm) for double ovens.

CUTOUT DIMENSIONS	
Height	41 to 41 1/2
Width	25 1/2
Depth	24
Bottom of cutout to floor (in-wall)	19 1/4
PRODUCT DIMENSIONS	
Height	42 9/16
Width	27
Depth	26 3/8
Depth with door open 90 degrees	46 3/4

All dimensions are shown in inches.

Dimensions are for planning purposes only.  
 For complete details, see Installation Instructions packed with product.  
 Specifications subject to change without notice.